







Assembly Instruction

SH105F24F2CT

PARKWOOD SPLATBACK SIDE CHAIR C.HGT WITH CUSHION

HARDWARE PARTS:

 8x1.1/4" Pan Head Screw 6 pcs	 M6x40mm JCBC Bolt 2 pcs	 M6x70mm JCBC Bolt 8 pcs	 M6x13mm Lock Washer 10 pcs	 M6.5x16.5mm Flat Washer 10 pcs	 M4X2.1/2" Allen Key 1 pc	 Glue 1 pc
--	--	--	---	---	---	---

ASSEMBLY:

- Position the chair back on a soft surface such as a carpet. Place the chair apron frame on to the middle rail of the chair back with the dowel fully inserted into the pre-drilled holes. Make sure that the screw holes on the apron frame are facing down.
 - Insert JCBC Bolt (Long) through a Lock Washer and a Flat Washer into the pre-drilled holes on the apron frame at rear corners.
 - Insert the JCBC Bolt (Short) through a Lock Washer and a Flat Washer into the pre-drilled holes on the apron frame at rear rail.
- Apply **Glue** to all the pre-drilled holes before attaching all stretcher. Insert each side stretcher into pre-drilled holes on both of the rear legs, make sure that screw holes on the stretcher are facing down. Insert the front stretcher into the pre-drilled holes on the front legs. Place the assembled front legs to corner block of the frame, and insert side stretcher into legs.
 - Insert the JCBC Bolt (Long) through a Lock Washer, a Flat Washer and the pre-drilled holes of corner block into the pre-drilled holes on the front leg, use the provided Allen Key but do not fully tighten the bolts yet.
 - Insert Pan Head Screw into side stretcher through the pre-drilled holes, tighten with screw-driver (Not Provided).

(STEP 1)

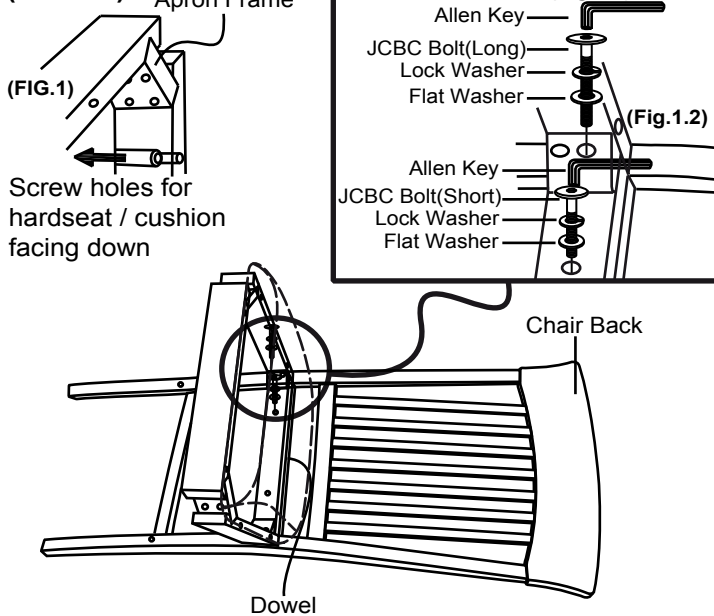

(STEP 2)

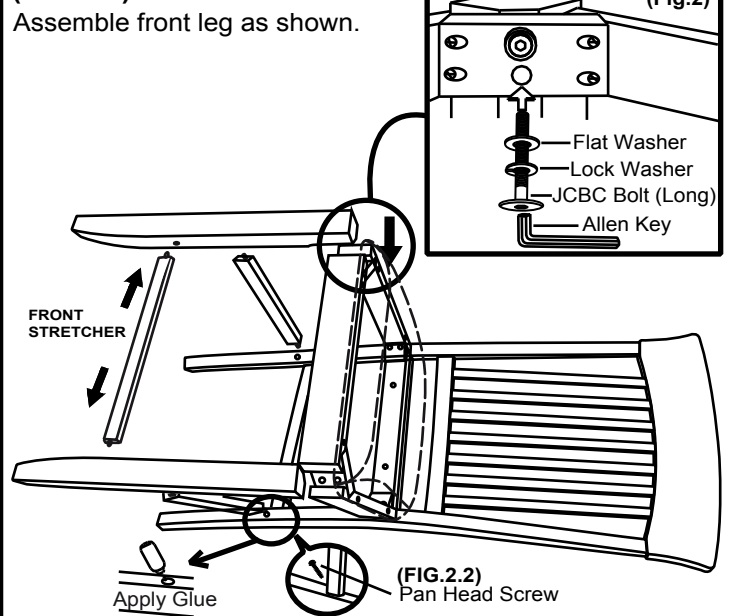

(STEP 3)

Turn the chair upright. Check its balance and tighten all screws and bolts to complete the assembly.

