

CHROMCRAFT[®]

 *Comfort in Motion*

chromcraft-revington.com
comfortnmotion.com

OPERATING MANUAL / SAFETY GUIDELINES /
INSTRUCTIONS / WARRANTIES
(for HCU #87)



RECLINER INNOVATIONS
FOR STRESS RELIEF COMFORT

April 24th, 2020

SAFETY GUIDELINES & PRECAUTIONS

IMPORTANT: Read these instructions thoroughly before using.



DANGER

- To reduce the risk of electrical shock, serious injury or death:

- Disconnect the chair electrical plug from outlet before cleaning, moving, servicing or when not in use for an extended period.
- Do not use this product if it is wet, in water, around water or any liquids. Do not plug in or use remote control with wet hands.
- To prevent suffocation, keep plastic bags away from children. Dispose plastic bags.
- Plug directly into a wall outlet. Do not use an extension cord, adaptor or surge protector.
- Keep cord out of reach of small children, and do not use where there may be a trip hazard.



WARNING

- To reduce the risk of electrical shock, serious injury:

- To avoid the possibility of tipping over, do not throw your weight against the back of the chair.
- Keep hands, fingers and body parts away from the mechanism. To reduce the risk of head entrapment and other injuries; keep children and pets away from openings and moving parts in and around furniture.
- Only the occupant should operate the chair. Never attempt to open the leg rest by pulling on it.
- Do not stand, sit, or place extra weight on the arms, back or open leg rest.
- To safely exit the chair, bring the back upright and close the leg rest.
- Do not use this product if it is damaged. Do not use attachments or substitute parts.
- Check the condition of the power transformers, electrical cords, plugs and connectors monthly. Keep the power transformers and electrical units away from heat sources. Never operate the chair with a damaged power transformer, electrical cord, plug or connector. Contact your local dealer you purchased this from for service.
- Be careful with containers with hot beverages in the cup holders. When the furniture moves into different positions, beverages may spill and cause injury. Do not place oversized or uncovered beverage containers in the cup holders. Use caution when placing containers within cupholders.
- Do not use chair if power control is damaged or wet. Do not use if hand controller dropped in water or any liquid. Contact your local dealer for service.
- Users of medical devices should contact their health care provider before using this product. Consult your physician regarding using the Zero Gravity PLUS position.

SAFETY GUIDELINES & PRECAUTIONS: continued

- Do not use this chair where aerosol spray products are being used or where oxygen is being administered. It could cause fire if motors are hot.
- Before moving the chair, disconnect the electrical plug from the wall outlet and secure the mechanism to prevent unexpected opening or movement. Never move the chair by the mechanism, leg rest, handle or reclining back.
- Do not attempt to disassemble or service the motor; service parts can be ordered through the dealer you purchased from.
- Do not allow electrical cord to be pinched between moving parts or between the frame and the floor. Do not place cord under carpet or in a location where it can become worn.
- Chairs are intended for a single occupant not exceeding 300 pounds per seat. Do not operate this chair with more than one person in it at a time.
- Unplug the power cord immediately if you detect strange odors or fumes coming from the chair.
- This product is not intended to be used as a replacement for a bed. It is not recommended to sleep in this chair for an extended period.
- When in operation and you must stop suddenly, you can press ANY KEY to stop operation. To resume, press key for your desired position.
- The electrical plug is a low voltage plug with transformer that must be plugged into a wall outlet properly before use.
- Do not smoke while using any type of upholstered chair.

NOTICE

- To reduce the risk of product damage:

- To prevent damage to the power transformer, do not plug in until you read the instructions.
- Never operate the chair except when it is on its base in the upright position.
- Some chair have cup holders. Take care to prevent spilling of beverages, which could damage the fabric or electrical units and hand controller.
- After 1 minute of continuous operation, allow back recline and leg rest extension features to rest for 10 minutes.
- Make sure chair is away from the wall when fully extended. Including cornered walls.
- Care should be taken in the unpacking of this chair, so as not to cause injury to persons or damage to the chair. Dispose of ALL plastic bags & covers, as they can be a smothering hazard to small children or pets.

UNPACKING INSTRUCTIONS AND PROCEDURES FOR START UP (recommend using two people to set up)

DANGER

1. Risk of serious injury or death: To prevent suffocation, keep plastic bags away from children.

Dispose of bags properly.



NOTICE

2. Risk of product damage: Never operate the chair until the restraining cable or fabric ties have been removed front and back of metal frame.

If chair has legs, screw on at this time before turning chair over.

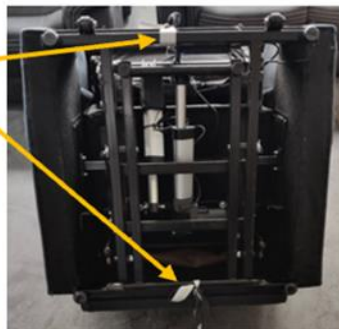

3. Turn chair base to its normal upright position.

4. Remove the hand controller unit (HCU), low voltage transformer wall outlet plug/cable from red bag.

5. Hook up cable of HCU into #1 socket on **control box**. See diagram of connection points on page 12 of this instruction manual.

6. Lay the chair back into seat and pull HCU up through the bottom center opening of back.

7. Connect the chair back cable wires to control box. See page 12 on connection points.

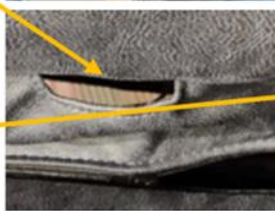
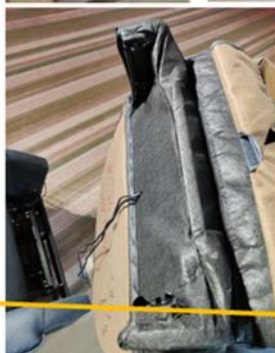

UNPACKING INSTRUCTIONS AND PROCEDURES FOR START UP-continued

8. Continue reading the operating manual on next page to assemble the chair back to metal back bracket post.

9. Place transformer low voltage plug into DC adaptor in lower back. DO NOT place wall plug into electrical outlet until chair back is assembled completely on next page.

10. Continue reading the operating manual for complete operation with booklet provided or go to www.chromcraft-revington.com or www.comfortnmotion.com for further instructions.

Batteries not included. Purchase from local store & install (2) 9 volt chargeable lithium batteries in the DC adaptor in back. Connect low voltage transformer plug into electrical wall outlet.



2-9 volt chargeable lithium batteries in DC adaptor - slide lid up to open



BACK ASSEMBLY



-To reduce the risk of injury:
Do not operate the chair until the back is installed and locked with hand controller in center back pulled through opening.

- To install the back; Align the back brackets with the body brackets. (figure 1).
- The back brackets will be in the outside or inside of the back assembly.
- Lower the chair back onto the body, making sure the back and body brackets are completely engaged.
- Push the locking levers down to lock the brackets (figure 2).

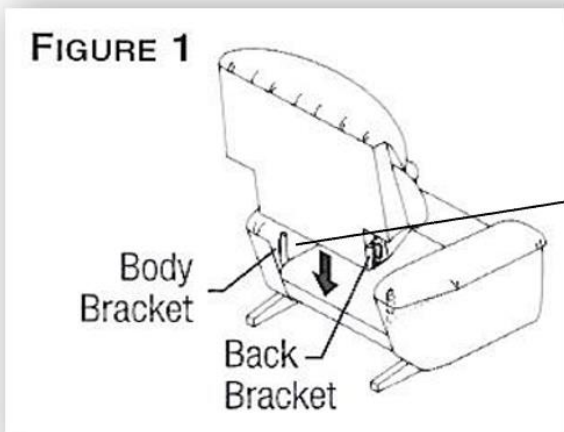

Body bracket



Back bracket

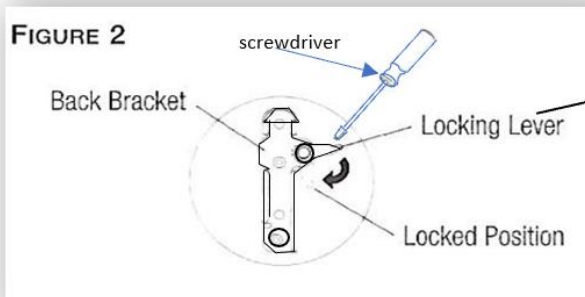

Back and Body Brackets Engaged and Locked
Locking Tab

- Take protective wrap off hand controller. It can distort the function of the positions. Do not plug in until all connections and back are in place. Do not sit in chair until it is activated using the hand controller unit (HCU). For activation please see page 7.
- For fabric and leather care and cleaning instructions, visit www.chromcraft-revington.com or www.comfortnmotion.com under CARE and ASSEMBLY or refer to dealer.



HAND CONTROLLER UNIT #87 FUNCTIONS for JK1087-T MECHANISM ACTIVATION

To Activate Hand Controller: (Remove Plastic Wrap)

1. Press & Release **HOME** Button
2. **Wait** for Movement to **STOP**.
3. Press & Release **HOME** Button.
4. Wait to go back into HOME position.

Hand Controller Now Activated

Note: Follow Steps Above After Unplugging or power loss.

1st Page



2nd Page

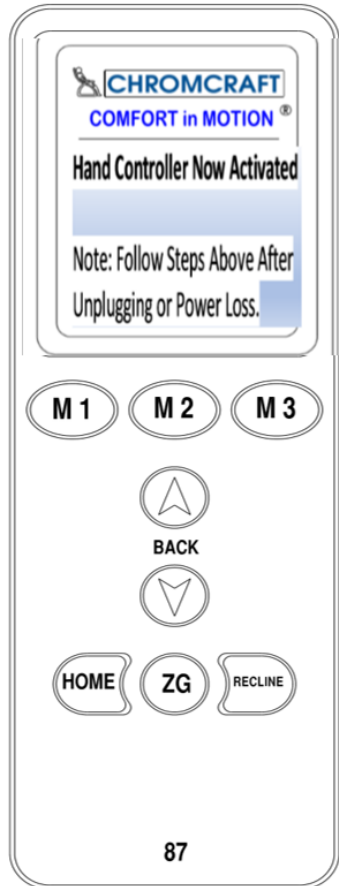

DISPLAY
ON LCD
SCREEN



HAND CONTROLLER UNIT #87 FUNCTIONS for JK1087-T MECHANISM

NOTICE

IF YOU PRESS ANY BUTTON DURING MOVEMENT, THE OPERATION STOPS. PRESSING ANY BUTTON CAN BE USED FOR EMERGENCY STOP OPERATION.



USB PORT on top to charge phone, Pad, etc.

LCD SCREEN notes positions in bottom of screen

MEMORY M1, M2, M3: PRESS & HOLD BUTTON FOR 3 SECONDS. ONCE LCD CONFIRMS OR MESSAGE SAYS, "SAVED M1,M2 OR M3 POSITION SUCCEED", THEN IT REMEMBERS THIS PRE- SET POSITION.

CUSTOM CONTROL:

PRESS AND HOLD  OR  FOR RECLINE BACK POSITION

RECLINE: PRESS AND RELEASE. GOES INTO RECLINE POSITION

ZERO GRAVITY: PRESS AND RELEASE. GOES INTO RELAXED POSITION OF BODY AT 127 DEGREES +/- 7 FOR ZERO GRAVITY.

HOME: PRESS AND RELEASE. GOES TO ORIGINAL PRE-SET HOME POSITION

NOTICE

WHEN POWER GOES OFF OR UNPLUGGED FROM WALL OUTLET, YOU MUST RE-SET SYSTEM BY:

- 1) PRESS HOME BUTTON, GO FULLY INTO POSITION.
- 2) PRESS HOME AGAIN, GO INTO FULL POSITION.
- 3) SYSTEM RE-ACTIVATED

BATTERY BACK UP SYSTEM

YOUR POWER RECLINER CHAIR COMES WITH A BATTERY BACK UP SYSTEM SO THE CHAIR CAN RETURN TO THE SEATED POSITION IN THE EVENT OF A HOUSEHOLD POWER FAILURE. FRESH STANDARD 9 VOLT BATTERIES (2) HAVE ENOUGH ENERGY TO BRING THE CHAIR TO A SEATED POSITION FROM EITHER RECLINE, ZG, ZERO GRAVITY PLUS, LIFT.

THE BATTERIES DO NOT HAVE ENOUGH ENERGY NOR ARE THEY INTENDED TO OPERATE THE CHAIR FOR A PORLONGED PERIOD OF TIME IN THE ABSENCE OF STANDARD HOUSEHOLD VOLTAGE. BATTERIES SHOULD BE REPLACED AFTER EACH USE.

BATTERIES MUST BE CHANGED ANNUALLY (SUCH AS WITH SMOKE ALARM BATTERIES). IT IS THE USER'S RESPONSIBILITY TO ENSURE THAT FRESH BATTERIES ARE USED IN THE BATTERY BACK UP SYSTEM. TO HELP ENSURE THE LONGEST LIFE OF THE BATTERY, USERS ARE ENCOURAGED NOT TO ALLOW THE HAND CONTROLLER TO BECOME WEDGED IN BETWEEN THE SEAT CUSHIONS AND THE CHAIR AS THIS MAY ACTIVATE THE HAND CONTROLLER AND CREATE A SLOW DRAIN OF THE BATTERIES.

REMOVE
PROTECTIVE
WRAP from
HCU



DC power adaptor

(2) – 9 volt back up chargeable lithium batteries. (not included).
NOTE: This is preinstalled into lower right back arm frame.

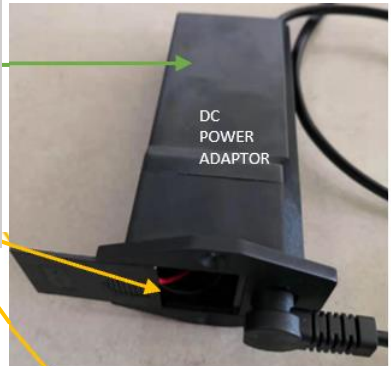

Low voltage
Transformer wall
plug
In for power – 24Volt



Control Box

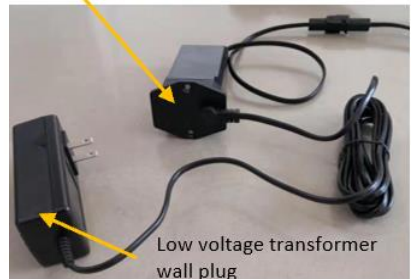

Low voltage transformer
wall plug

CARE AND MAINTENANCE

Your power chair will require routine maintenance checks. You can perform some of these checks, while others may require assistance from your dealer. By following these maintenance checks, you can make sure your power chair gives you years of trouble-free operation. If you have any questions or concerns regarding your lift chair's care and maintenance, contact the Dealer where purchased.

- This chair is intended for indoor use only.
- Before cleaning your chair, consult your dealer for the proper types of cleaner and cleaning methods.
- Keep all electrical components free from moisture and liquid spills.
- Periodically inspect all wiring harnesses to make sure they are not cut, damaged, frayed, or disconnected. If damage of any type is present, unplug the lift chair and contact the Dealer.
- Periodically check all fasteners for tightness, wear, and corrosion. If any of these are present, unplug the lift chair and contact the Dealer.

Warning: Be careful of pinch points and sharp metal parts (wear gloves).

- Replace the back up batteries after one use. Replace the batteries yearly, even if they were not used. Batteries are only intended for one use only!
- PARTS LIST shown in electrical diagram on last page.



the standard in safety

File E342113

Underwriters
Laboratories



Shenzhen Anbotek Compliance Laboratory Limited

Address: East of 4/F, Building A, Hourai No.3 Industrial Zone, Xixiang Street, Bao'an District, Shenzhen, Guangdong, China
Tel: (86)755-26066061 Fax: (86)755-26066021 Email service@anbotek.com

AB-RHS-03-a

Hotline
400-003-0500
www.anbotek.com

TROUBLE SHOOT COMMON FAULT REASONS & SOLUTIONS

| Problem | Possible Reasons | Solutions |
|--|--|---|
| <p>Chair stops working or LED RED light of low voltage transformer comes on</p> | <ol style="list-style-type: none"> 1. Connection of motors could be incorrect. 2. Electric plug is in wall outlet incorrectly. 3. Incorrect voltage in wall outlet. 4. Overload 5. Loose connections. | <ol style="list-style-type: none"> 1. Check the connections. Follow the wiring diagram on page 12. 2. Check the electric plug & circuit breaker in home. 3. Make sure household outlet is 110V. Input to motor from transformer will be 29/2A. 4. Unplug & refer to Step 3. Plug in. Follow up the action for re-activation. 5. Unplug. Check connection again. Then plug back in. Power will come back on HCU. Re-activate. |
| | <p>NOTE: Green LED light-system OK.</p> | |
| <p>Hand Controller Unit HCU does not go into positions properly.</p> | <ol style="list-style-type: none"> 1. Remove a protective wrap from HCU. It will hinder operations. 2. HCU wire cable not plugged into control box #1. | <ol style="list-style-type: none"> 1. Be sure to remove protective wrap. 2. Check reconnection of HCU into control box. See wiring diagram. 3. Re-activate. |

System MUST be re-activated when power goes off or when unplugged.

To Re-Activate:

1. Press & Release **HOME** Button
2. **Wait** for Movement to **STOP**.
3. Press & Release **HOME** Button.
4. Wait to go back into HOME position.

Hand Controller Now Activated

HCU #87 for 1 motor system – JK1087-T ELECTRICAL CONNECTIONS & PARTS:

Step 1 - plug hand controller wire to control box. Match #1 to #1.

Step 2 - plug the black wire from the wire of main foot motor #2 to the control box marked #2.

Step 3 - plug the power cord into the power adaptor from the control box.

Step 4 - plug into wall outlet with the transformer low voltage plug.

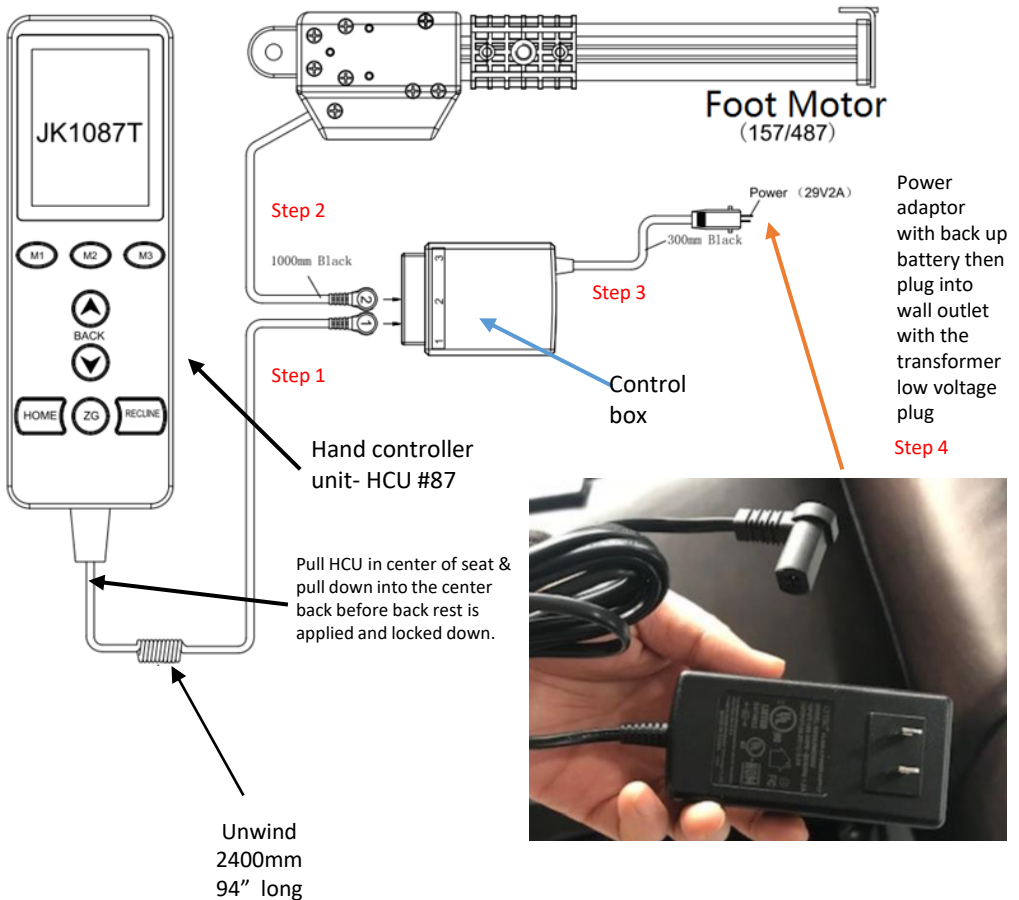



Warranty

This chair was designed for residential use only. Placement in rental property, institutions or any other excessive application voids these warranties.

Limited Lifetime Warranty: the items listed below are warranted to be free of defects in materials and workmanship for as long as the original consumer owns the furniture.

- Mechanism – refers to the chairs reclining mechanism and lift mechanism
- Interior wood frame components & OKE slats.

7 Year Warranty: items listed are warranted to be free of defects in materials and workmanship to the original consumer for 7 years from the date of purchase.

- Main base, foot & lumbar & headrest motors

5 Year Warranty: items listed are warranted to be free of defects in materials and workmanship to the original consumer for 5 years from the date of purchase.

- Seat cushion cores
- Seating springs
- Back cushion filling.

3 Year Warranty:

Hand controllers and control box

1 Year Warranty: items listed are warranted to be free of defects in materials and workmanship to the original consumer for 1 year from the date of purchase.

- Upholstery fabrics including leather
- Lumbar / lumbar flex mechanisms

This warranty covers seam failure, fabric separation and nap loss. Excluded from this warranty are cover piling, fading, stretching and dye lots. Natural markings such as scars, brands, grain variations, wrinkles etc. will be considered normal characteristics and not construed as defects but as nature's marks as no two cow hides are the same.

Where there is evidence of excessive soiling, improper cleaning, abuse or where the fabric or leather has had some form of chemical applied, the fabric / leather warranty will not apply.

Warranty Service

Claims for any warranty service must be made with the original authorized retailer where the chair was purchased & within a reasonable life of the products. All requests for warranty service must include the proof of purchase to the original purchaser to satisfy warranty requirements.

Chromcraft will, at its option repair and /or replace the defective part(s) and or components provided that the warranty parts have not been subject to abuse, misuse or improper service by the consumer or that the parts have not been damaged in transit and /or altered or repaired by unauthorized representatives.

The warranty does not include costs for unnecessary service calls, calls solely for the purpose of educating the consumer about their chair, or finding an unsatisfactory power connection etc.

Exceeding the weight limit for the chair as stated in the owner's manual will automatically void all warranties.

For the first year Chromcraft will pay all reasonable shipping charges for warranted parts or components. After the first year it will be the consumer's responsibility to pay for the cost of transportation, handling, and packing of the warranted parts or components. Chromcraft will not be responsible or obligated to pay for any costs or expenses for the examination of any warranted claims.

1011 S. Grove Ave.
Ontario, CA 91761
Telephone #909-930-9891



1457 Industrial Park Dr.
Sardis, MS 38666
Telephone #662-562-8203